

Thyristor&Diode Module

V_{RRM} / V_{DRM}	800 to 1600V
I_{FAV} / I_{TAV}	200 Amp
I_{FRMS} / I_{TRMS}	314 Amp



Features

- Aluminum oxide DBC
- Glass passivated chip
- High surge capability

Applications

- Power converters
- Lighting control
- DC motor control and drives
- Heat and temperature control

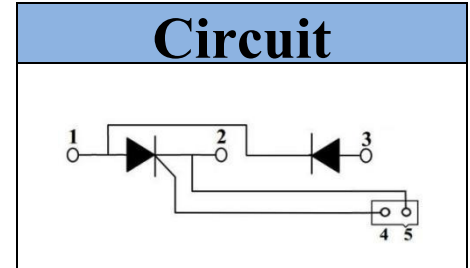

Module Type

Type	V_{RRM} / V_{DRM}	V_{RSM}
MFC200G-08	800V	900V
MFC200G-12	1200V	1300V
MFC200G-16	1600V	1700V

Maximum Ratings

Symbol	Item	Conditions	Values	Unit
I_{FAV}/I_{TAV}	Average On-state Current	180° Conduction Sin Half Wave, $T_c = 82^\circ C$	200	A
I_{FRMS}/I_{TRMS}	RMS On-state Current		314	A
I_{FSM}/I_{TSM}	Surge On-state Current	$T_j = 25^\circ C, t = 50Hz(10ms), V_R = 0V$	6300	A
I^2t	Circuit Fusing Consideration	$t = 10ms, T_j = 25^\circ C$	198450	A ² s
V_{ISO}	Isolation Breakdown Voltage	AC 50Hz/60Hz; R.M.S; 1min	3000	V
T_j	Operating Junction Temperature		-40 to + 125	°C
T_{stg}	Storage Temperature		-40 to + 125	°C
M_t	Mounting Torque	To Terminals(M6)	5±15%	N·m
M_s		To Heatsink(M6)	5±15%	
Weight	Module (Approximately)		180	g
di/dt	Critical Rate of Rise of On-state Current, Max	$T_j = 125^\circ C,$ $V_D = 1/2V_{DRM},$ $I_G = 150mA,$ $di_G/dt = 0.1A/\mu s$	150	A/μs

Thermal Characteristics

Symbol	Item	Conditions	Values	Unit
$R_{th(j-c)}$	Thermal Impedance, Max	Junction to Case(Per Leg)	0.13	°C/W
$R_{th(c-s)}$	Thermal Impedance, Max	Case to Heat Sink	0.05	°C/W

■ Electrical Characteristics

Symbol	Item	Conditions	Values			Unit
			Min.	Typ.	Max.	
V_{FM}/V_{TM}	Peak On-State Voltage, Max	$T_j = 25^\circ\text{C}$, $I_F/I_T = 600\text{A}$	-	-	1.60	V
I_{DRM} $/I_{RRM}$	Repetitive Peak Reverse Current, Max /Repetitive Peak Off-state Current, Max	$T_j = 125^\circ\text{C}$, $V_R = V_{RRM}$, $V_D = V_{DRM}$	-	-	35	mA
V_{GT}	Gate Trigger Voltage, Max	$T_j = 25^\circ\text{C}$, $V_D = 6\text{V}$	-	-	3.0	V
I_{GT}	Gate Trigger Current, Max	$T_j = 25^\circ\text{C}$, $V_D = 6\text{V}$	-	-	150	mA
V_{GD}	Gate Non-Trigger Voltage, Max	$T_j = 125^\circ\text{C}$, $V_D = 2/3V_{DRM}$	-	-	0.25	V
I_L	Latching Current	$T_j = 25^\circ\text{C}$	-	200	-	mA
I_H	Holding Current	$T_j = 25^\circ\text{C}$	-	150	-	mA
t_{gt}	Turn On Time	$T_j = 25^\circ\text{C}$	-	3	-	μs
dv/dt	Critical Rate of Rise of Off-state Voltage, Min	$T_j = 125^\circ\text{C}$, $V_D = 2/3V_{DRM}$ Linear Voltage Rise	1000			V/ μs
V_{T0}	Threshold Voltage, for power loss calculation only	$T_j = 125^\circ\text{C}$	0.86			V
r_T	Slope Resistance, for power loss calculation only	$T_j = 125^\circ\text{C}$	1.3			m Ω

Performance Curves

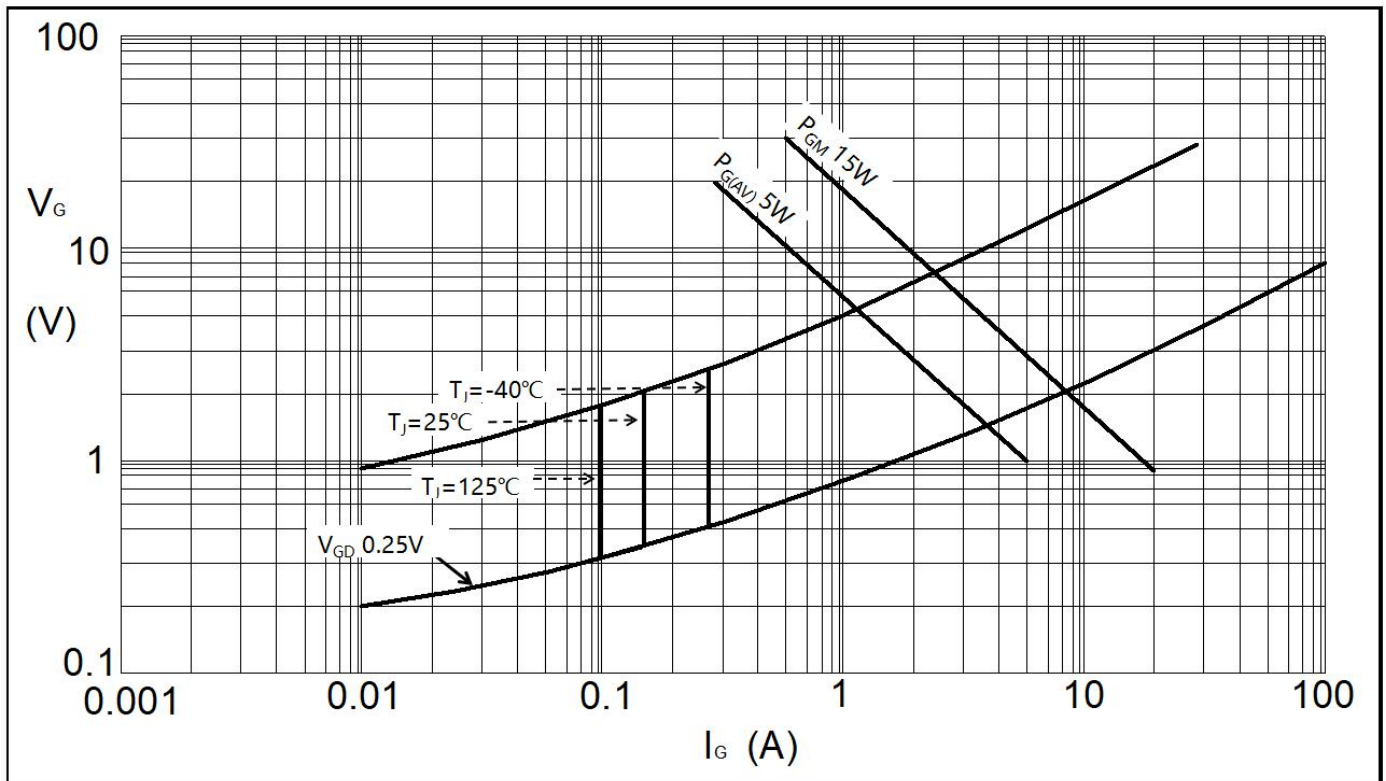

Fig1. Gate Trigger Characteristics

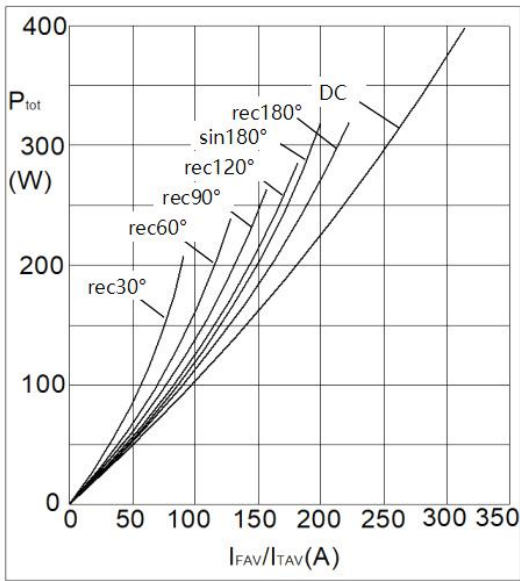

Fig2. Power Dissipation

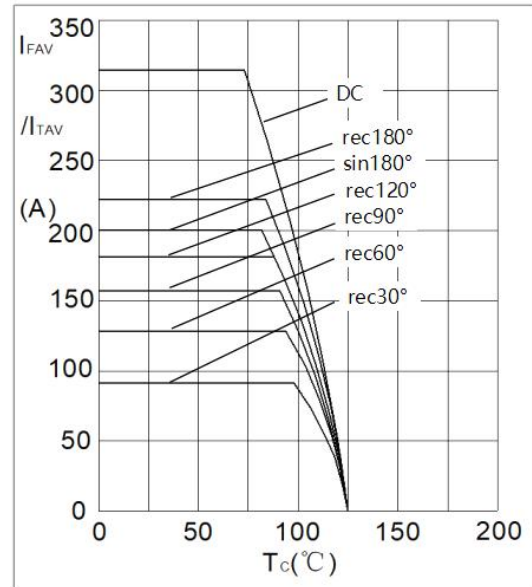

Fig3. Forward Current Derating Curve

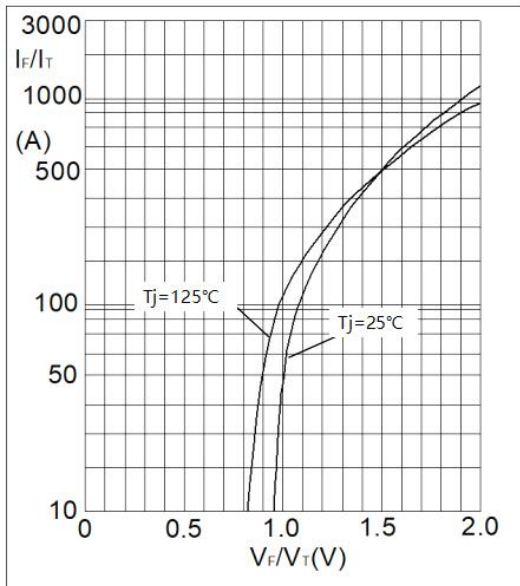

Fig4. Forward Characteristics

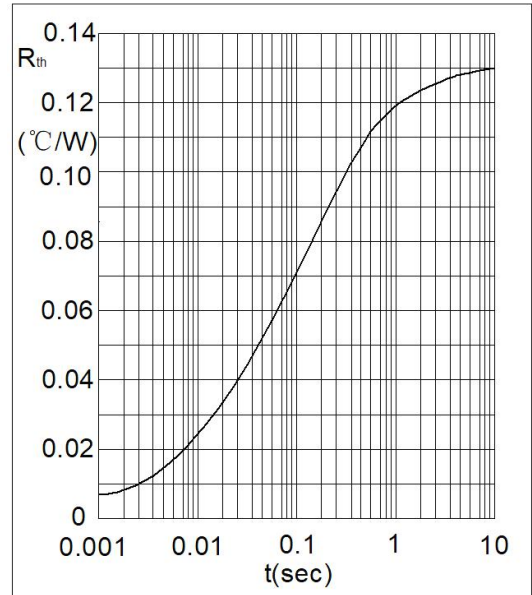

Fig5. Transient Thermal impedance

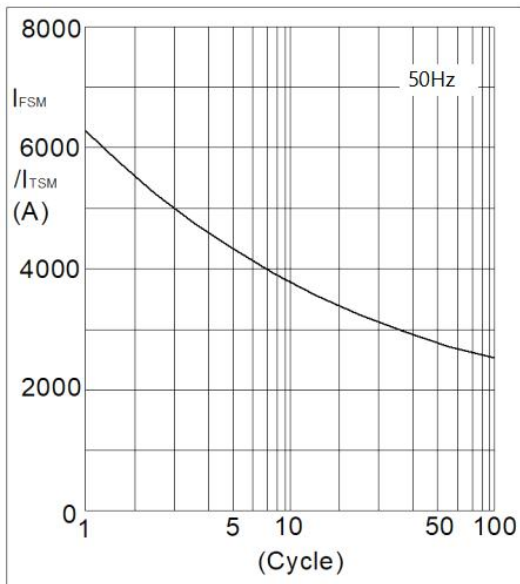
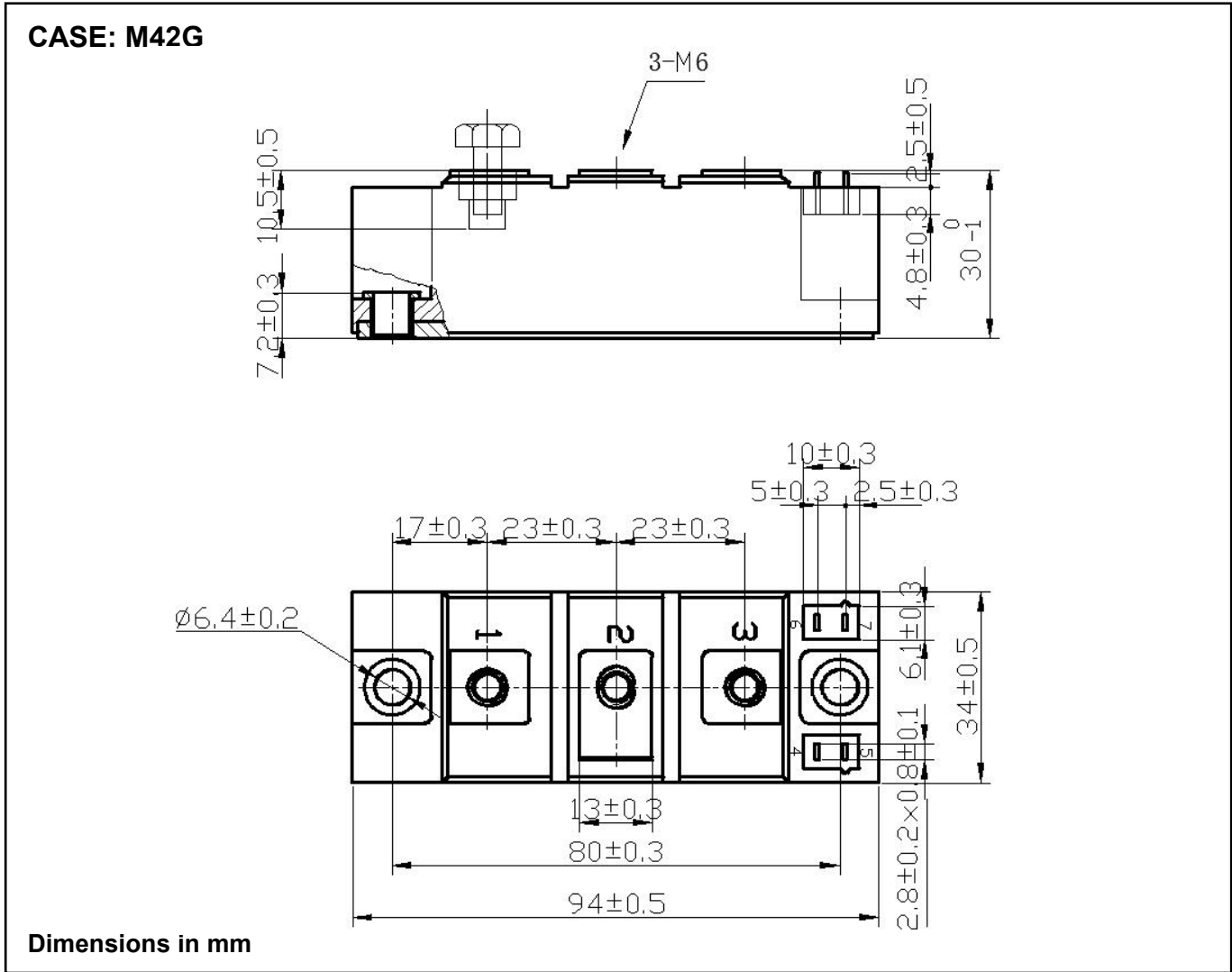

Fig6. Max Non-Repetitive Forward Surge Current

Package Outline Information



***IMPORTANT INFORMATION AND WARNINGS**

The specifications of Zhejiang Guchi Electronics Co., Ltd. products may not be considered as a guarantee or assurance of product characteristics. The specifications describe only the usual characteristics of products expected in typical applications, which may still vary depending on the specific application. Therefore, products must be tested for the respective application in advance, and application adjustments may be necessary. The user of our products is responsible for the safety of their applications embedding our products and must take adequate safety measures to prevent the applications from causing physical injury, fire, or other problems if any of our products become faulty. The user is responsible for ensuring that the application design complies with all applicable laws, regulations, norms, and standards. Except as otherwise explicitly approved by Zhejiang Guchi Electronics Co., Ltd. in a written document signed by authorized representatives, our products may not be used in any applications where a failure of the product or any consequences of the use thereof can reasonably be expected to result in personal injury.

No representation or warranty is given, and no liability is assumed with respect to the accuracy, completeness, and/or use of any information herein, including without limitation, warranties of non-infringement of intellectual property rights of any third party. Zhejiang Guchi Electronics Co., Ltd. does not assume any liability arising out of the applications or use of any product; neither does it convey any license under its patent rights, copyrights, trade secrets, or other intellectual property rights, nor the rights of others. We make no representation or warranty of non-infringement or alleged non-infringement of intellectual property rights of any third party which may arise from applications. Due to technical requirements, our products may contain dangerous substances. For information on the types in question, please contact the nearest sales office. This document supersedes and replaces all information previously supplied and may be superseded by updates. We reserve the right to make changes.